

SAMSUNG

Technical Solution

Architectural Manual

staron[®]
Solid Surfaces



TECHNICAL SOLUTION

Staron are not only high quality but also a versatile premium interior material. To help realize a designer's ideas, we bring the technical know-how and help address inquiries through our Technical Solutions.

Both Staron strive to make your dreams a reality.



PROCESS

EXAMPLE

Thermoforming sheet

Staron sheets become flexible when heated at a constant temperature. At this state, it can be molded to a desired 2D,3D form and smooth curves can be created

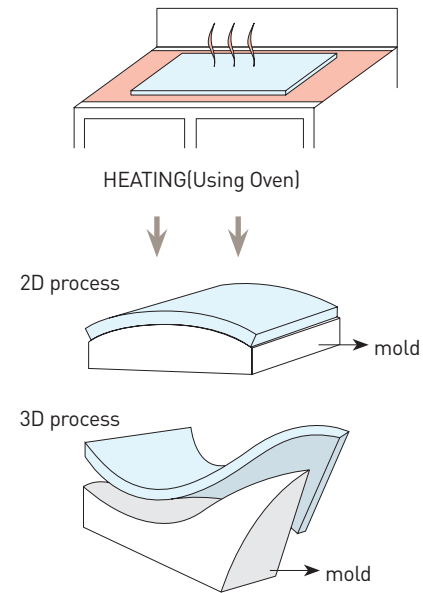

PROCESS

EXAMPLE

Thermo processing

Staron material consists of acrylic resin so when constant heat is applied, it can be formed to various desired shapes.

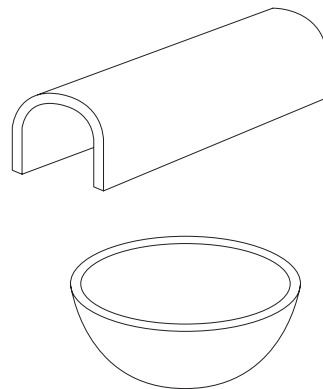

PROCESS

EXAMPLE

Easy cutting edges

Staron is easy to handle even on difficult, narrow or curved edges where wood working tools can be used to cut edges.

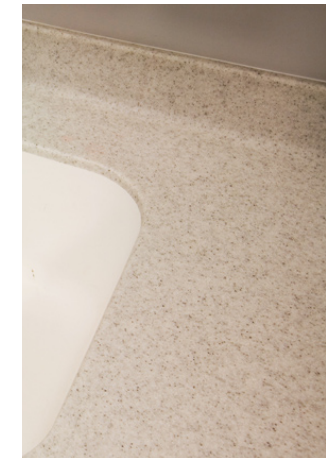
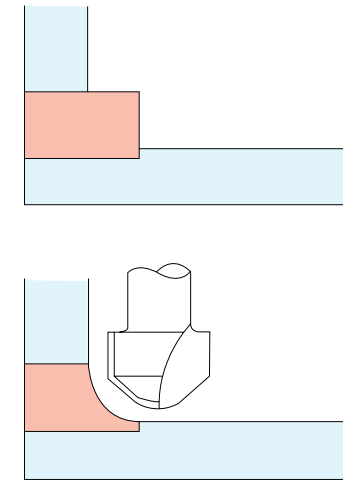

PROCESS

EXAMPLE

Invisible joints

Use the adhesive Methacrylate to adhere the joints and sand the surface for visibly seamless completion of the construction.

When a color matched adhesive is used, seamless joints can be created with sanding.

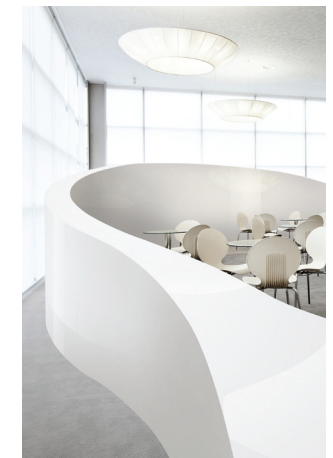
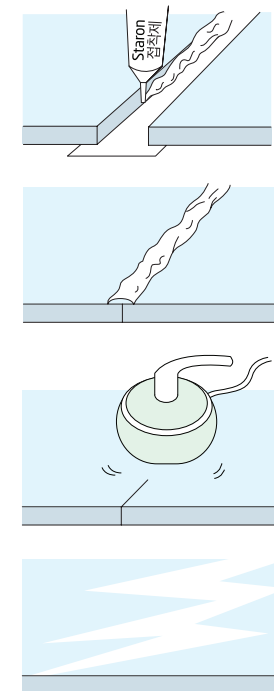

PROCESS

Various processing methods 1

Staron solid surface allows you to seamlessly integrate multiple colors that can be bonded together to create a new design pattern.

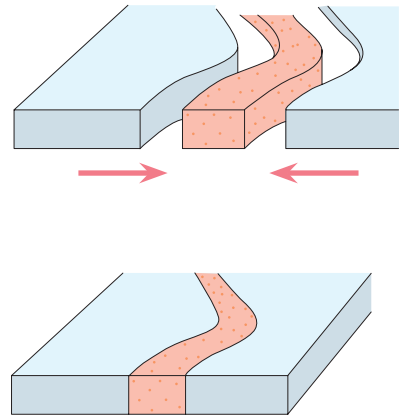

EXAMPLE



PROCESS

Various processing methods 3

Staron has a lower hardness than natural stone so you are able to use a wood working CNC to create precise grooves (Mohs hardness: 2-3). You are able to create an interior that embodies what the designer wants.

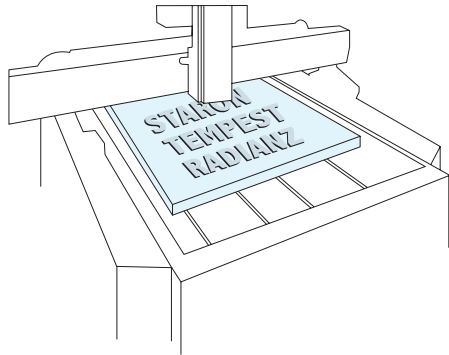

EXAMPLE

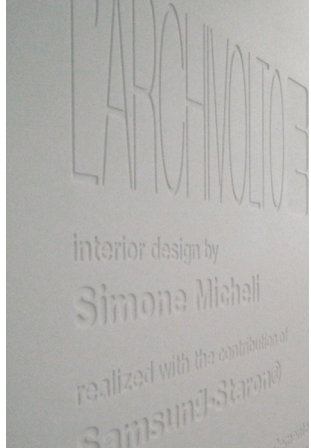

CNC: Computer processed cost calculations of alterations

PROCESS

Various processing methods 2

When adding letters or patterns, use an inlay technique by cutting out a similar shape on a board and place a different colored plate.

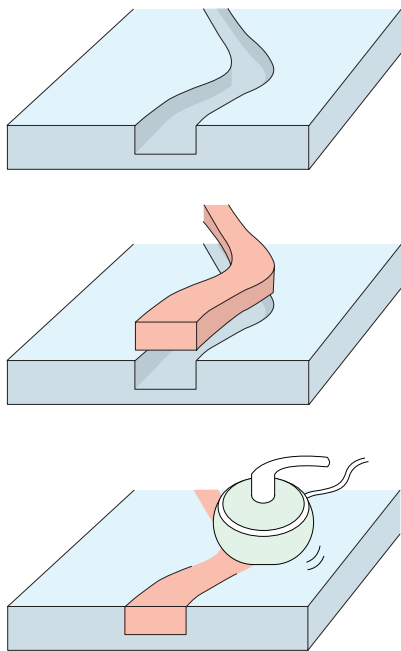

EXAMPLE



PROCESS

Various surface finishes

Utilizing the polishing process, you can obtain your desired surface such as Matte, Satin, and Gloss. For high usage areas like kitchen counters, we recommend a matte finish.

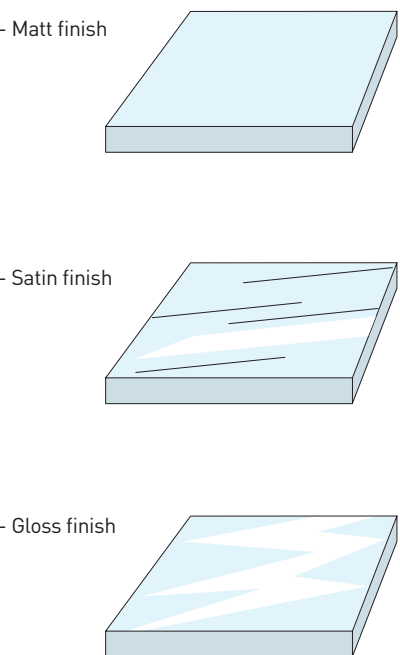

EXAMPLE



PROCESS

Subtle light transmittance

Staron's material thickness affects the illumination of the light. Depending on the space, the level of light emitted can be modified to create a fantastic look to the interior space. If the light is illuminated in the seams or causes thermal expansion and contraction, it can damage the lighting installation so it is advisable to avoid these areas.

EXAMPLE

PROCESS

Hygienically safe material

Unlike natural stones, Staron's non-porous surfaces prevent bacteria or fungi growth, and has low moisture absorption rate.

EXAMPLE

PROCESS

Environmentally conscious material

Staron is manufactured under stringent quality / environmental standards. Staron is compliant to safe chemical standards RoHS, does not contain Phthalates, Greenguard certified and other meets various other environment related standards.

EXAMPLE

PROCESS

Smart easy restoration material

You can prolong the newness of your product over a long period of time with easy maintenance that will keep seamlessly.

EXAMPLE



EDGE 1

Various edge designs

Make the interior you seek through modern but classic designs

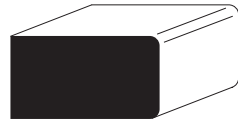

Straight

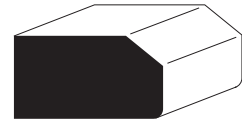

5, 10mm Bevel

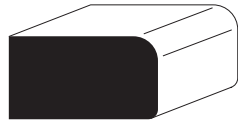

5mm Round

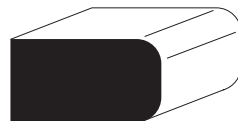

5mm Round T&B



Half Bullnose

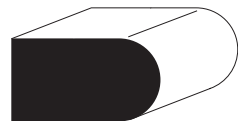

Full Bullnose



EDGE 2

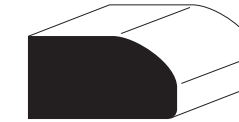

Demi bullnose



Ogee



Cove Ogee



Stair Thread



Waterfall

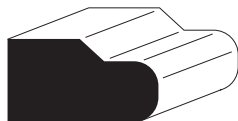

Single Imperial

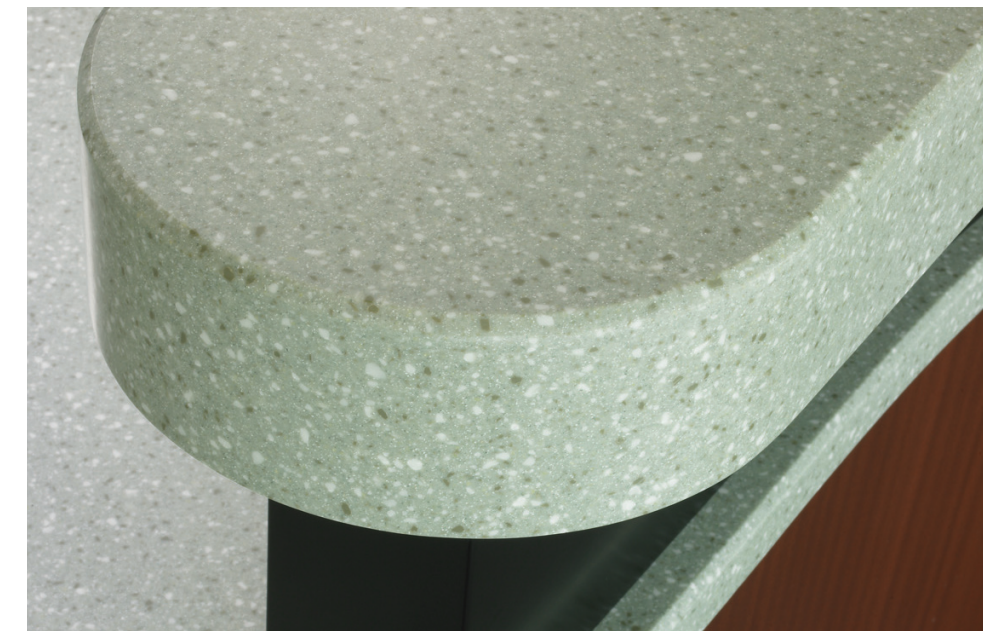

Staron exterior material characteristics

When Staron is used as an exterior material, there are many advantages as noted below

- High tensile strength, flexural strength and shock strength
- Easy to handle to produce desired shape
- Easy to maintain and restore as if new by cleaning and sanding
- Low water absorption
- Resistant to stains and environmental contaminants
- Excellent flame retardancy

Although there is no major impact to physical properties, but when exposed for an extended period of time, it can reduce the gloss or a risk of discoloration.

These changes are more noticeable on dark colors or where the saturation is high.

However, it is possible to recover the original color and luster through sanding and polishing methods.

Notifications

Use discretion and carefully consider the characteristics of the material when using Staron as an exterior material. The responsibility of this decision is up to the user or designer. Staron warranty does not apply for external use. For external use, we recommend products that are under 5 chrominance and have been tested with ASTM G 155 and KS K 0911 which simulated 10 years of weathering results.

For external use, we recommend 5 products that have been tested with ASTM G 155 and KS K 0911 which simulated 10 years of weathering results.

Bright white, Pure white, Quasar white, Pearl,
 Sanded cornhusk, Sanded Icicle, Sanded Heron, Sanded ginger,
 Sanded papyrus, Sanded white pepper,
 Aspen Glacier, Aspen snow,
 Pebble gold, Pebble lagoon, Pebble maize, Pebble moon, Pebble spinel,
 Pebble chiffon, Pebble kernel, Pebble frost,
 Quarry stoneware, Quarry coral

Installation method

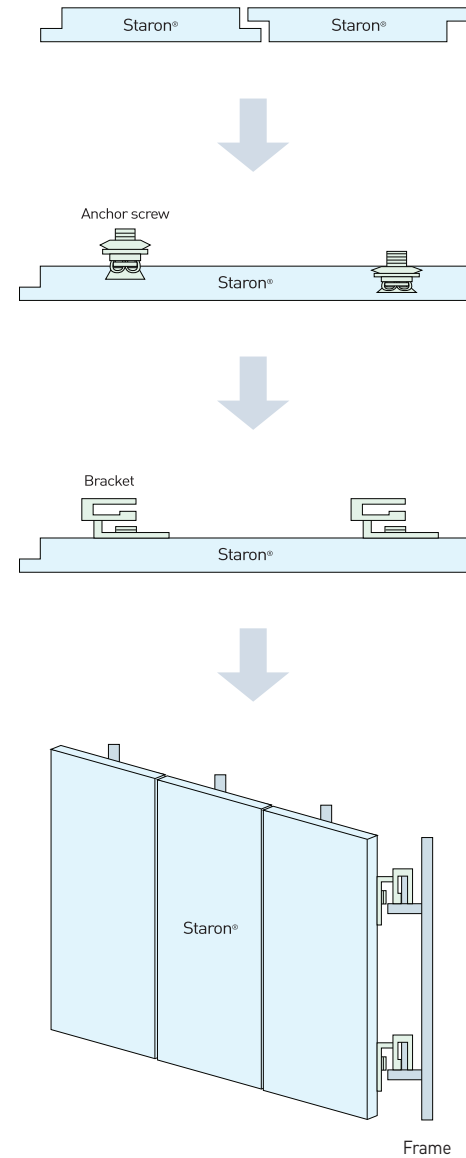

- CNC Machine the Edges

- Use wet hole drilling machines for screw holes.
- Anchor screws into the hole and fill with approved glue.

- Use a combination of aluminum brackets screws and bolts.

- Assemble the brackets to the frame.
- The installation requires the support of specialized vendors (eg. Fischer)

Constructing interior walls with Staron

Staron's smooth surface finish complements a stylish upgrade to that completes the configuration of the wall.

Base panels

- When adhesive is applied to the base two panels, there should not be any bends and must be free of dust and other debris.
- Moisture-resistant plywood, MDF board, cement board, tile surface etc are recommended as a base panel.

Adhesives

- We recommend using 100% silicone sealants to account for the expansion and contraction of sheets.
- To seamlessly bond boards with adhesive, consider the thermal expansion/contraction prior to construction.

Staron sheets

- 6mm, 9mm, 12mm thick wall sheets are possible
- Colors and sheet thickness affect the light transmittance of Staron sheets. If using a back light, pre-test the material as studs and remaining adhesives in the back may show through as a shadow.

Processing precautions 1

- Trim 12mm larger than actual dimensions.
- Use a router to make all cuts.
- When using adhesive to bond Staron sheets, use a mirror cut. If mirror cut is not used in this case, there is a possibility of a visible seam.
- When moving adhesive sheets, use caution for safe handling.

Processing precautions 2

- When adhering rectangular panels with 100% silicone adhesives, apply adhesive in 30cm intervals.
- Allow 3mm spacing between panel edges.
- Use a router or a Rotozip when punching holes.
- No holes should be punched while the panels are attached to the wall.

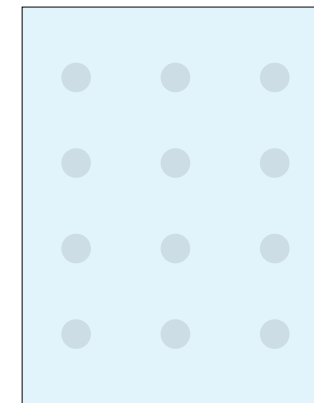

- Before the silicon is cured, use hot glue to secure the sheets.

Processing precautions 3

- Check to make sure the wall sheets sit flat against the wall.
- If it is being installed with a glass door, ensure there is 3mm spacing between the mirror door and the sheet.
- Silicone adhesive must be evenly distributed and sheets must be firmly fixed to the wall.
- After attaching the front wall panel, cut the side wall panel to the correct dimensions.
- After installing the side panels, finish the edges with a silicone sealant.
- All joints must use 100% color matched silicone to finish the edges.
- Wipe down all wall panels and joints with an alcohol wipe

Using adhesives on wall panels

1. Cut edges in a 45 degree angle.

- Cut the seams of each of the two sheets 3mm from the edge using a router at a 45 degree angle.
- Seams should be positioned 2mm apart from any cutouts and adhered with a silicone sealant.
- Clean the edges with denatured alcohol

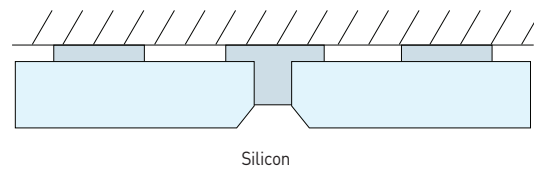

2. Seamless joints and bottom reinforcements.

- To adhere the sheets with adhesive, mirror cut the sheets.
- To prevent cracking of the boards in the future, reinforce the back with 3 layers.
- Prepare adequate space for thermal expansion and contraction of the sheet.

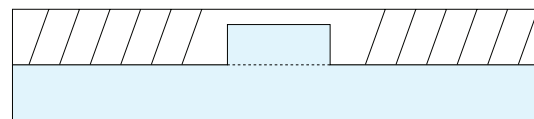

Thermoforming process

The thermoforming process is one of the methods used to process Staron by heating and bending flat sections of Staron® sheets to create curved tops and down stands. It is a learned technique that requires practice and experience in order to achieve optimal results.

If you are utilizing a thermoforming method described below, do a trial run of the process in the same condition of the actual run to ensure success.

Safety

- When adhesive is applied to the base two panels, there should not be any bends and must be free of dust and other debris.
- Moisture-resistant plywood, MDF board, cement board, tile surface etc are recommended as a base panel.

Mold

- A precise thermoforming mold must be prepared to the exact desired dimensions
- The mold is produced with 3mm plywood and MDF Boards. To precisely fix the shape, a male/female mold is needed.
- The mold must be strong enough to withstand the pressure during processing.

Recommend R processing size

Pattern	Thickness(mm)	Min. Inside radius(R)
Solid, Sanded	6mm	25mm
	12mm	76mm
Aspen, Pebble	6mm	102mm
	12mm	127mm
Quarry, Metallic	12mm	203mm

We do not recommend this process for Tempest/Mosaic

Thermoforming process

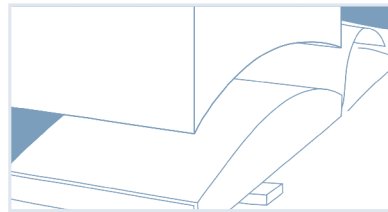

1. MOLD

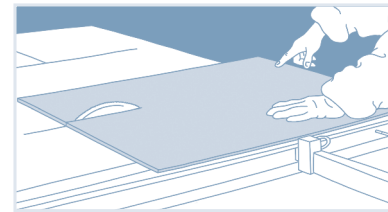

2. CUTTING

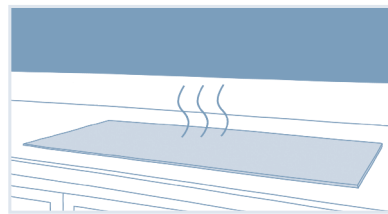

3. HEATING(Using Oven)
(Heating at 145~165°C)

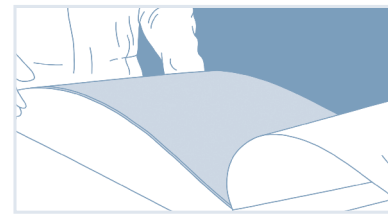

4. FORMING

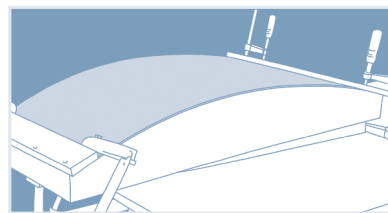

5. FIXING & COOLING

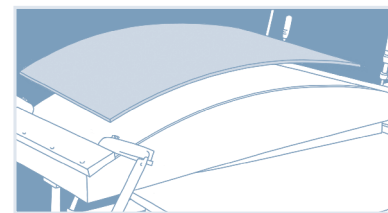

6. INSTALLATION 1

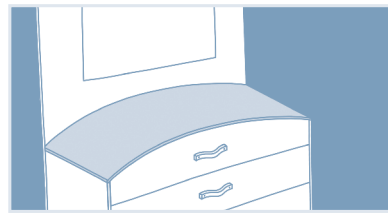

7. INSTALLATION 2

Comparing Staron to other products

Staron is extremely durable but also easy to work with. Differentiated from other products in both benefits and reliable quality, you will feel the difference in your use.

Attributes	Staron solid surface	Polyester solid surface	Engineered stone	Granite	Stainless steel
Ease of maintenance/ Cleanability and repair	3	3	2	1	2
Does not support microbial growth	3	3	3	1	3
Nonporous smooth	3	3	3	1	3
Low flammability	3	2	3	3	3
Durable	3	3	3	3	3
Low VOC	3	3	3	3	3
Low smoke toxicity	3	1	3	3	3
Initial and life cycle cost effectiveness	3	3	3	1	2
Slip resistance-appropriate coefficient of friction	3	3	3	3	2
Ease of installation, demolition, replacement	3	3	1	1	2
Seamless appearance	3	3	1	1	3
Control of reflectivity	3	3	2	2	2
Option for color, pattern	3	3	3	2	2
Nontoxic, non-allergenic	3	3	3	3	3

www.staron.com

SAMSUNG CHEMICAL (USA), INC.

14251 E. Firestone Blvd. La Mirada, CA 90638 U.S.A.
Tel : +1-562-926-5520, Fax : +1-562-926-9930
+1-800-795-7177

SAMSUNG CHEMICAL EUROPE GMBH

Am Kronberger Hang 6, Samsung House D-65824,
Schwalbach/Ts., Germany
Tel : +49-6196-667-403, Fax : +49-6196-667-467
Free Hotline in Germany : 0800-1-782766

DUBAI OFFICE

Samsung Chemical Europe Gmbh Dubai Rep. PO Box 48969
Flat No 2403, Al Shafar Tower 1, Tecom, Greens, Dubai, U.A.E.
Tel : +971-4-447-3411, Fax : +971-4-447-3412

SHANGHAI OFFICE

Rm2701, Shanghai International Trade Center,
2201 West Yan an Rd, Shanghai, China, 200336
Tel : +86-21-62703000-856, Fax : +86-21-62756882

SAMSUNG CHEMICAL (THAILAND) Co., Ltd.

16th Floor, Empire Tower, Unit 1602-1603, 195 South Sathorn Road,
Yannawa, Sathorn, Bangkok 10120, Thailand
Tel : +66-2-624-6737, Fax : +66-2-624-6780

HEAD OFFICE

332-2, Gocheon-Dong, Uiwang-Si,
Gyeonggi-Do, Korea, 437-711
Tel : +82-31-596-3856, Fax : +82-31-596-3882